



**G6** SERIES

**GANTRY TYPE 5-AXIS VERTICAL  
MACHINING CENTER**



# WE ARE AXILE

AXILE designs and builds agile smart 5-axis VMCs with leading automation solutions for manufacturers of complex parts and components.

**“ We believe manufacturers shouldn’t have to choose between high-speed and high-performance 5-axis machines. ”**

By combining sheer agility, digitalized intelligent automation, and a new standard of 5-axis machining, we’ve created an all-new approach:

## **Agile Smart Machining.**

In short, our dedicated team of industry experts brings together ultra-high removal rates, pinpoint precision, and 24/7 automation and reliability within each and every AXILE 5-axis machine.

Our breakthrough design concepts and advanced proprietary technologies serve highly sophisticated manufacturers of complex parts and components for applications in aerospace, die and mold, medical, and general job shop, among others.

The AXILE service and support network spans nearly 50 countries, with more than 70 distributors across Asia, Europe, and the Americas, and a service center in Croatia, Canada, Germany, USA.



# CONTENTS

## **4 G6 GANTRY TYPE VMC**

DESIGN CONCEPT

AGILITY

ACCURACY

SPINDLE

CHIP MANAGEMENT

TOOL MANAGEMENT

ERGONOMICS

CONTROL UNIT

MILL-TURN

## **15 TECHNOLOGIES**

SMT™ - SMART MACHINING TECHNOLOGY

## **16 AVAILABLE ACCESSORIES**

## **18 LAYOUT AND WORKSPACE**

## **24 TECHNICAL DATA**

# G6 GANTRY TYPE VMC

## SUSTAINABLE MACHINERY

AXILE is actively integrating sustainability principles into its business model. We keep investing on R&D and focus in supplying flexible & sustainable manufacturing solutions to boost productivity and profitability. We believe that only by embracing digitalization, our customers will achieve a pledge of sustainable development respectful of people and the environment with the necessary competitiveness to ensure the survival of their business.

AXILE digitalization was launched for an optimized machine monitoring and a better energy saving management, compliant with ISO 14955. We aim to help our customers to be prepared to the challenges of the power consumption reduction and to mitigate the carbon emission taxes generated by the manufacturing process.

With a rotary table diameter of 600 mm, the G6 is a compact vertical machining center designed for agile, smart machining of smaller workpieces requiring complex geometries and intricate features. This highly versatile VMC delivers full 5-axis CNC machining, with the built-in spindle moving along the X,Y,Z-axis, and the table moving in rotary C-axis and swiveling A-axis.

The G6's perfect balance of speed and precision makes it the perfect option for job shops and production lines seeking an upgrade in machining capabilities, delivering high removal rates, excellent surface finishes, and maximum production efficiency.



# DESIGN CONCEPT

## THE STRUCTURE

1

Spindle moved by 3 linear axes

No rotary axis between the tool and the machine body, for better machining rigidity.

4

Massive gantry sliding on 2 symmetric synchronized axes

Best servo response to any milling forces

2

Perfect U-shape closed gantry design

Same stability in all travels of X and Y axes  
Excellent accessibility to working area

5

All body made of high-quality casting

Homogeneous thermal behaviour  
Optimal damping of machining vibrations

3

Table moved by swivelling rotary axes

Best accuracy with fixed relative position between 2 rotary axes

6

Integrated chip disposal channel directly under the table

Quick evacuation of chips for high chip volume machining

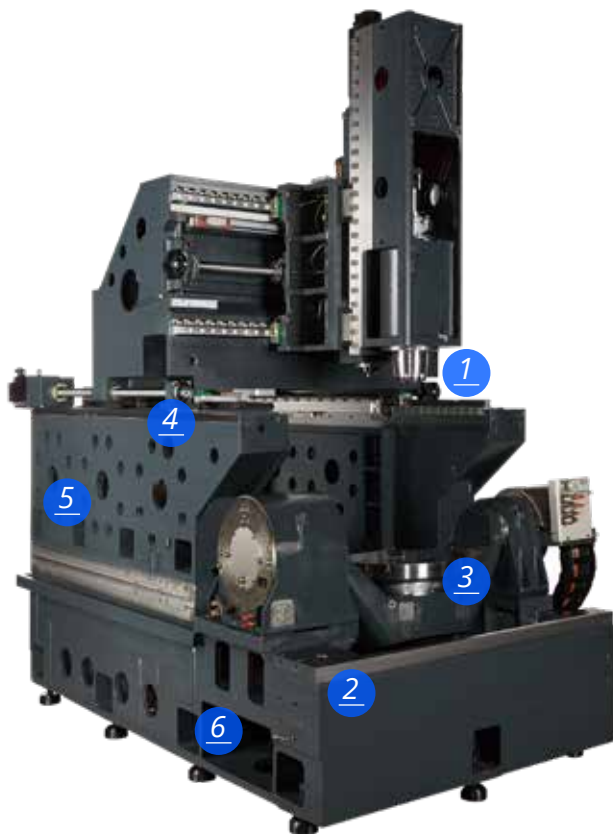

G6 front



G6 back

# AGILITY

## LINEAR AXES

1

Direct driven servomotors (no belts/gears)

Best dynamic and minimal elasticity in the driving system

2

Double symmetric and synchronized axes (Y, V axis)

Best dynamic for the gantry no matter the position of the machining force

Linear scales with 0,1  $\mu\text{m}$  resolution in Y, V axis and Z axes

Ensures optimal synchronization in Y and V axes, and best accuracy for ALL axes

Double roller type linear guideways

Best high-feed movement and vibration damping

Double pre-loaded double-nut ballscrews

Minimized backlash allowing high-feed movements

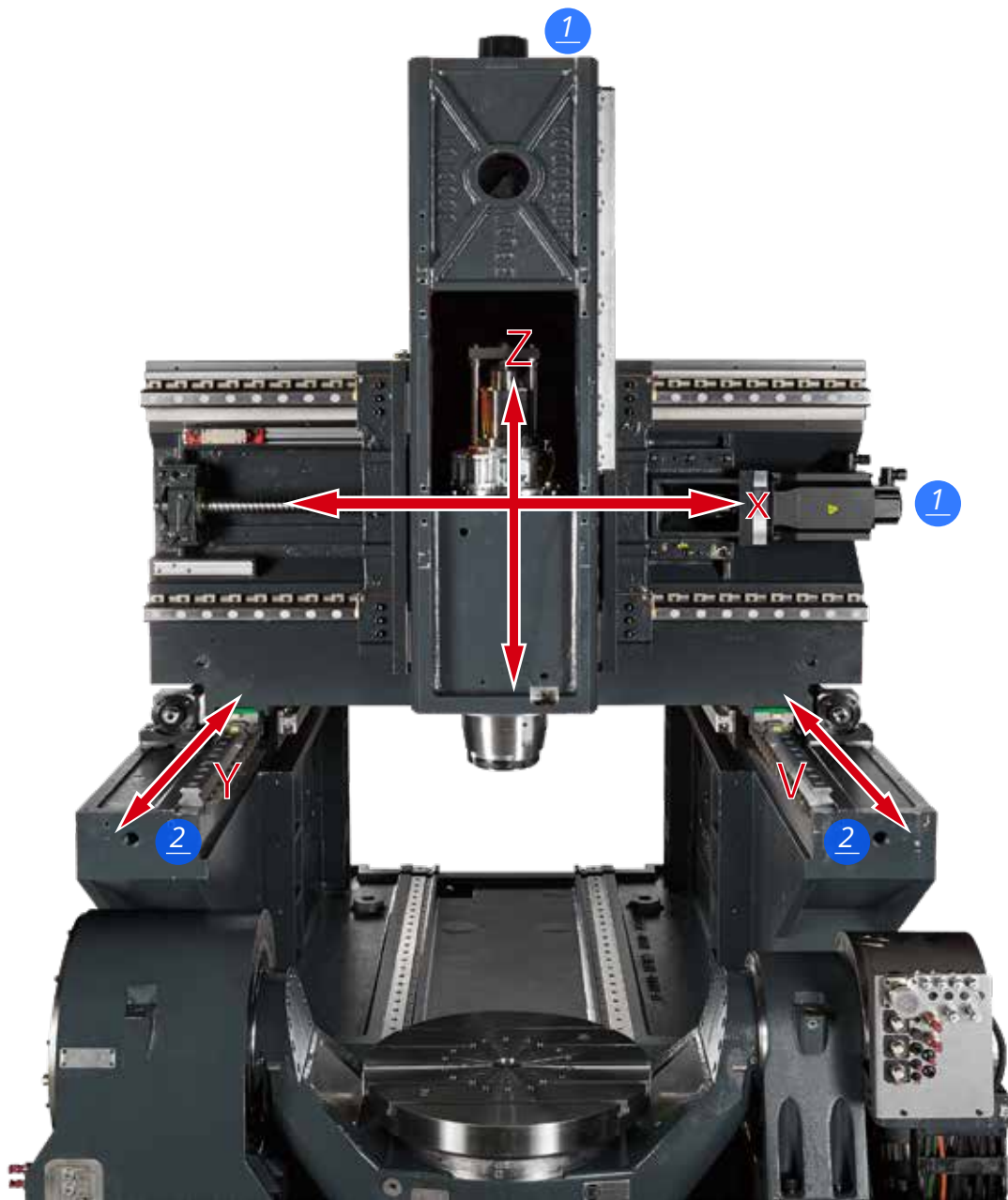

# SWIVELLING-ROTARY AXES

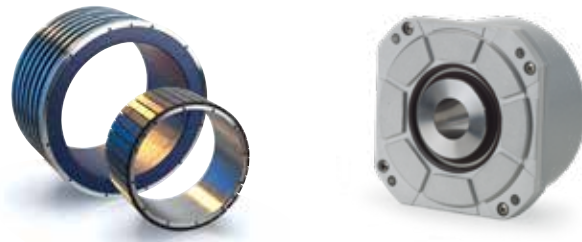

1

Integrated and ready-to-use hydraulic and pneumatic ports

Simplifying parts clamping process

2

Torque motor-driven rotary axis (C)

Highest dynamics

Torque motor-driven swivelling axis (A)

Highest accuracy

Brakes in rotary (C) and swivelling (A) axes

High-repeatability in 5-axis operation when using the brakes

3

High-resolution, direct absolute rotary measuring system

Zero-backlash and high accuracy



G6 Standard table

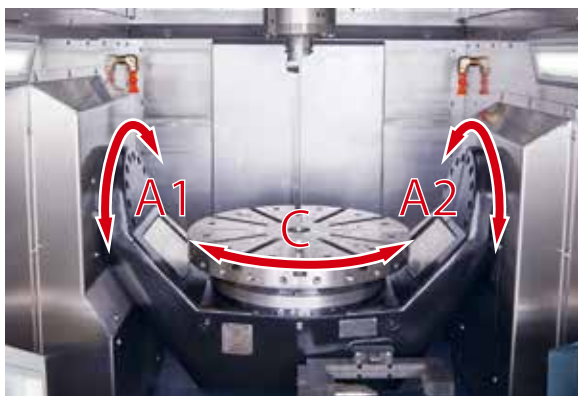

G6 MT table



G6 MPC table



# ACCURACY

## THE CORNERSTONE OF 5-AXIS MACHINING

### Linear axes accuracy

Ballscrew's thermal growth

0.1 $\mu$ m resolution absolute linear scales in ALL axes



### Rotary axes accuracy

Elasticity and backlash of driving system

Direct-driven torque motors with no backlash

Angular error is multiplied by the distance from rotary axis to machining point

+/- 5" accuracy absolute rotary scale feedback



### Thermal control

Heat generated by spindle and torque motors

Spindle and torque motors are cooled with a water chiller close-circuit and a cooling unit



### Linear-rotary axes relative positioning

The swivelling-rotary table might shift its relative position to the 3 linear axes by many reasons generating an increasing error in the part

CNC embedded compensating functions like Kinematics (Heidenhain), Kinematic chain (Siemens) and Tilted working plane indexing (Fanuc)





# SPINDLE

## HIGH-PERFORMANCE BUILT-IN SPINDLE SELECTION



- > 15.000 rpm
- > HSK A63
- > 127/166 Nm S1/S6-40%
- > 30/38 kW S1/S6-40%
- > Double coil asynchronous motor

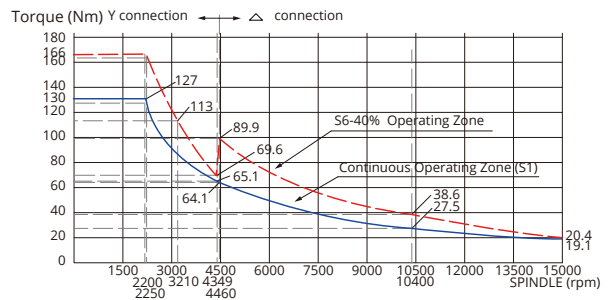
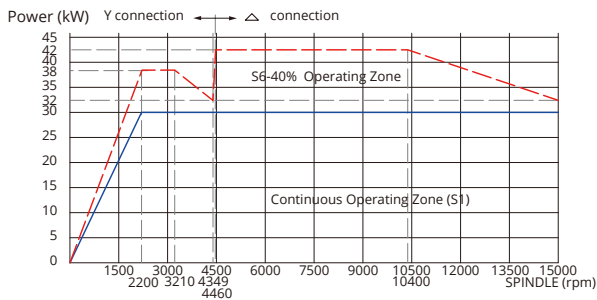

- > 20.000 rpm
- > HSK A63
- > 86/111 Nm S1/S6-40%
- > 25/32 kW S1/S6-40%
- > Double coil asynchronous motor

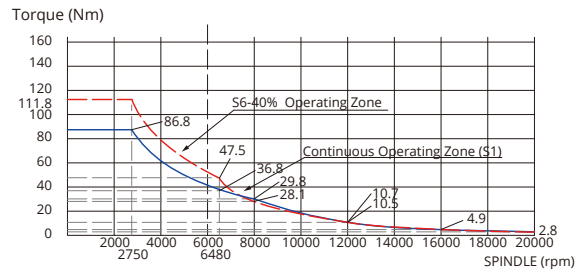
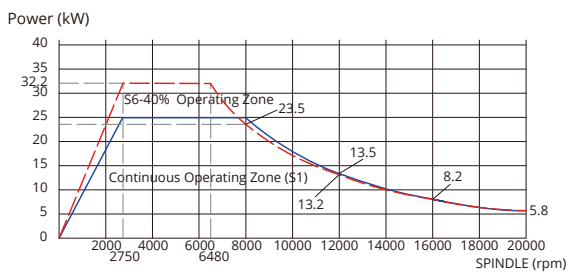

- > 36.000 rpm
- > HSK E50
- > 10.4/13.5 Nm S1/S6-40%
- > 20/26 kW S1/S6-40%
- > Single coil asynchronous motor

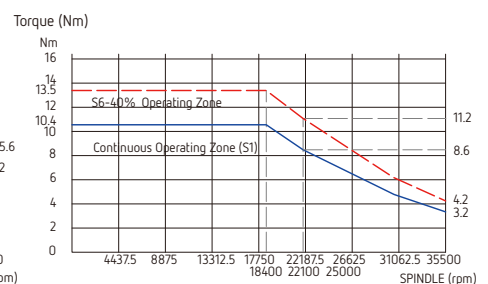
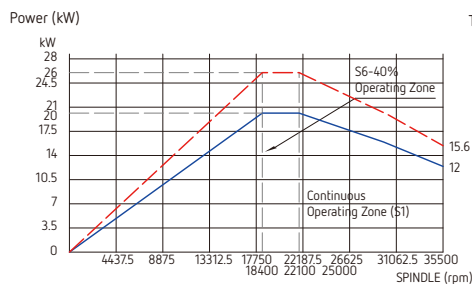
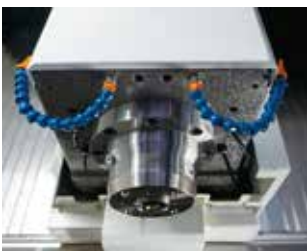

# CHIP MANAGEMENT

## FLUSHING CHIPS AWAY



High-quality stainless steel working area

Long-lasting clean operation

Sharp walls and no-corner design

Easier to flush away chips by shower

1 Coolant through spindle

2 Coolant flushing

3 Air flushing

4 Chip wash down

5 Chip conveyor

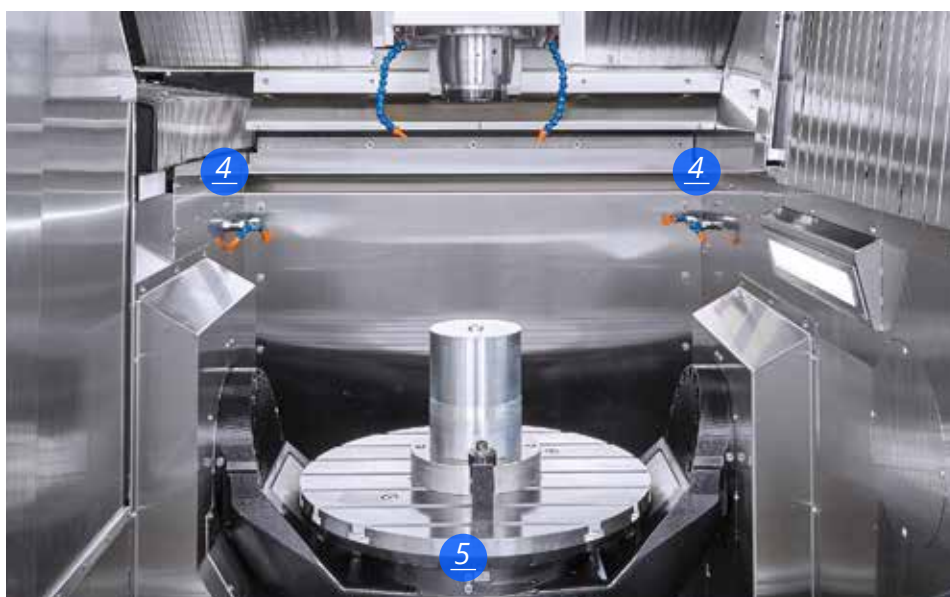

# TOOL MANAGEMENT

## TOOL MAGAZINE SELECTION FOR EVERY APPLICATION

1

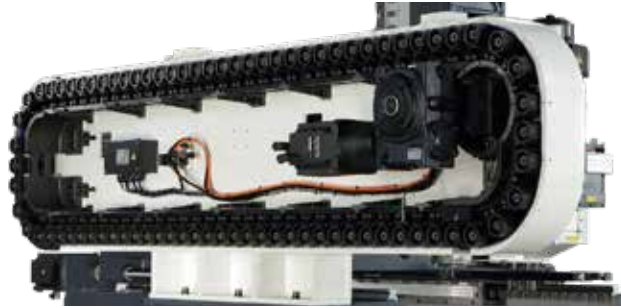

2



1

Simple random type carrousel for 80 (std) or 120 tools.

Fastest tool change and optimized space saving.

2

Matrix rack magazine is available with 3 different sizes of 164, 242 and 320 tools.

Perfect solution for multi-pallet automation with bigger number of different parts and need for sister tools to reach a practical unmanned operation.

Tools are accessible from the front-left side of the machine and stored in horizontal.

Tools can be easily changed during automatic operation in the same area for machining supervision, CNC panel and workpiece loading and unloading.

Smart tool: interface panel is used to select the tool. When finished, the system checks whether all tool holders are in the right position.

Avoid human failures when manually change tool to spindle, protecting spindle and reducing down-time.

# ERGONOMICS

## ACCESSIBILITY TO WORKING AREA

Large front door opening	Comfortable access to work area for workpiece preparation and supervision
Short distance from operator to table	Ergonomic loading and unloading of small parts
Automatic roof to open ceiling working area	Easy loading and unloading of heavy and bulky workpieces by over-head crane



## AUTOMATIC ROOF

For overhead crane loading and unloading



Automatic sliding of roof

# CONTROL UNIT

## A CONTROLLER FOR EVERY USER

### Siemens SINUMERIK ONE

- > Kinematics chain
- > Collision Avoidance
- > 5-axis transformation with tool orientation
- > Swivel the Coordinate System

### Fanuc 31i-B5 plus

- > 3D Interference Check
- > High Speed Smooth TCP
- > Tilted Working Plane indexing

Fanuc 31i-B5 plus



Siemens SINUMERIK ONE



### Heidenhain TNC 640 / TNC7

- > Kinematics
- > Dynamic Collision Monitoring
- > Tool Center Point Management
- > Tilted the Working Plane

Heidenhain TNC 640



Heidenhain TNC7





# MILL-TURN

Mill-turn for those looking for the maximum integration of metal-cutting processes in a single step, reducing complexity of the process and chance of error in the clamping.



C-axis motor is cooled as in the milling version. Additionally the C-axis bearing is cooled in the inner and outer to ensure the long lasting accuracy and life.

Table diameter: 500 mm  
Max turning speed: 1500 rpm  
Max table load in turning: 350 kg  
Max table load in milling: 500 kg



Integrated balancing system that can be monitored from the additional screen located on top of the panel, with the help of a sensor located in the A-axis (opt)

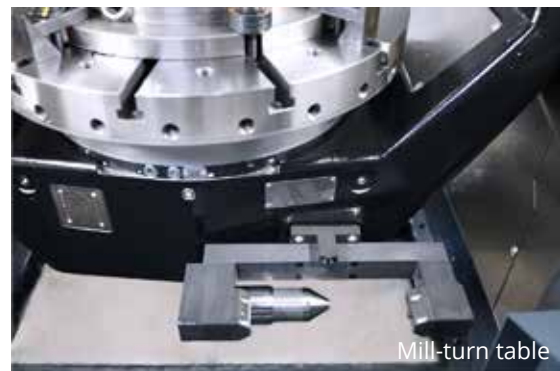

Mill-turn table

The mill-turn table equips with a specially designed mechanical and laser type tool measurement system.

# TECHNOLOGIES

**SMT™**

## SMART MACHINING TECHNOLOGY

As pioneers of advanced mechatronic systems with decades of R&D expertise, AXILE has taken 5-axis CNC machining to the next level. Our patented SMT™ (Smart Machining Technology) delivers groundbreaking compensation and calibration functionality for unrivaled cutting speeds and industry-leading accuracy, and more importantly, resolves the aforementioned issues created by thermal expansion.

With AXILE's SMT™ manufacturers can have it all. There's no longer the need to choose between speed and precision, meaning manufacturers can produce superior parts rapidly, while also securing total process reliability and long-term machining performance.



### Axial Accuracy Control



- > **AXIAL THERMO MONITORING**  
Integration of temperature sensors and thermal error model
- > **HIGH PRECISION**  
Thermal induced positioning error compensation

Thermal Error Before and After Compensation

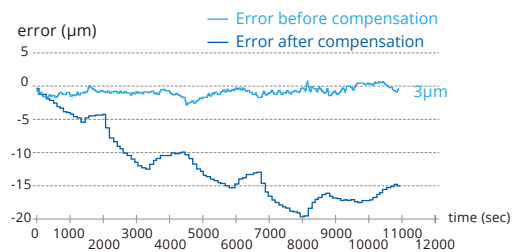

With thermal compensation system, the thermal error can be reduced from 20µm to 3µm.



### Tool-tip Positioning Control



- > **HIGH ACCURACY**  
Directly measuring expansion
- > **BETTER SURFACE FINISH**  
5~6 times accuracy improved
- > **REAL-TIME COMPENSATION**  
Electrical type sensor

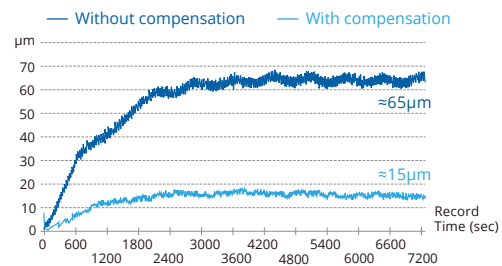

With compensation, the displacement of tool tip is reduced from 65µm to 15µm.

**ACCURACY IMPROVED 5~6 TIMES!**



### Spindle Vibration Supervision

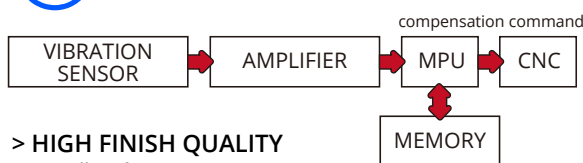

- > **HIGH FINISH QUALITY**  
Spindle Life Time
- > **LONGER LIFE TIME**  
Wear reduction on spindle bearings and tools

Three Levels for Spindle Vibration Monitoring

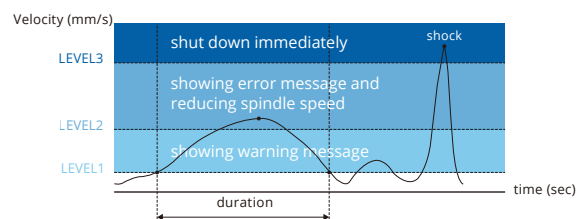

- > **EASY FOR MAINTENANCE**  
Up to 12000 abnormal vibration data recording



# AVAILABLE ACCESSORIES

Optional design and organization of electrical connectors and cables

Easier maintenance

High-speed and twisting stress cycles



G6 Standard

All necessary consumables are located together in the side of the machine

Easier maintenance routine for operator



G6 MPC

Chip conveyor with coolant through spindle are available on demand.

Different types of chip conveyor are available for different chip material.



Integrated and ready-to-use 3 hydraulic and 1 pneumatic port. Clamping and unclamping functions by softkeys in the control panel and/or by M-function.

Simplifies 5X workpiece clamping.

*Standard for standard table.  
MT table is optional.*



Automatic workpiece measurement (with probe, receiver and reference ball)

Automatic compensation of the linear-rotary axis relative positioning:  
Kinematics (Heidenhain), Kinematic chain (Siemens) and Tilted working plane indexing (Fanuc)

For accurate workpiece positioning or in-process measuring of some machining features.



U-type embedded in the table (for highest accuracy).  
Laser tool measurement.



Spin window

For easier view of working area when huge amount of coolant and chips are produced



Separate type CTS unit including :

- > Cartridge filter
- > Paper filter
- > Through spindle 40 & 70 bar centrifugal and screw pumps
- > Oil skimmer
- > Oil cooler

Recommended for high aluminum or cast iron material



Scapper type chip conveyor

Chain type conveyor takes bigger and curly chip away. Scrapper type conveyor takes smaller and lighter chips as well as dusty chips away.

# LAYOUT AND WORKSPACE

■ Metric  
■ Inch

## G6 (80 tools ATC and with chain type chip conveyor )

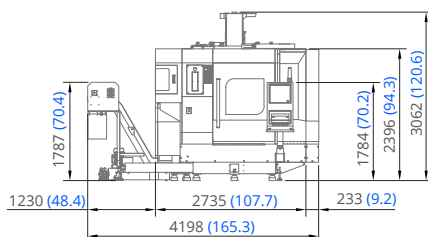
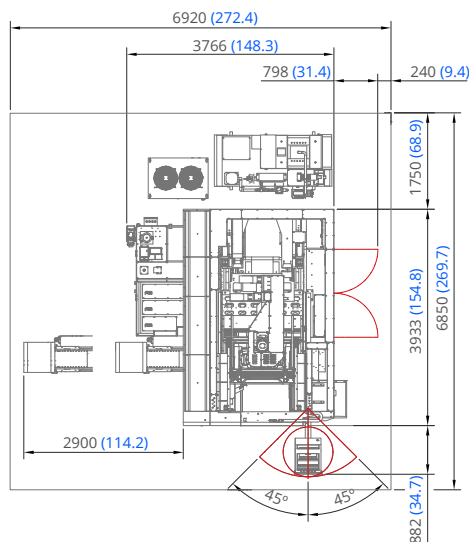

## G6 (120 tools ATC and with chain type chip conveyor)

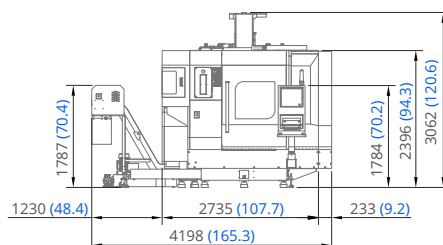
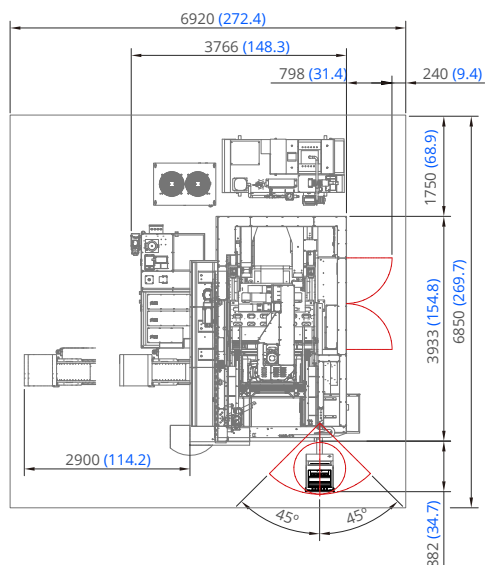

**G6 (with 80 tools ATC and scrapper type chip conveyor)**

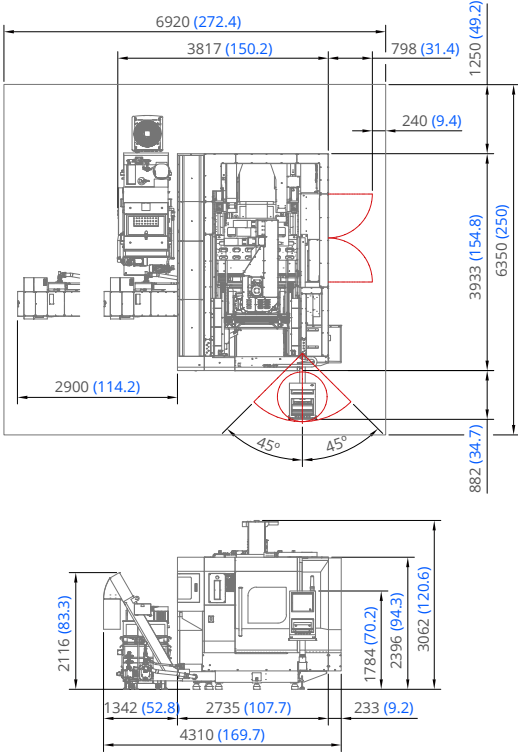

**G6 (with 120 tools ATC and scrapper type chip conveyor)**

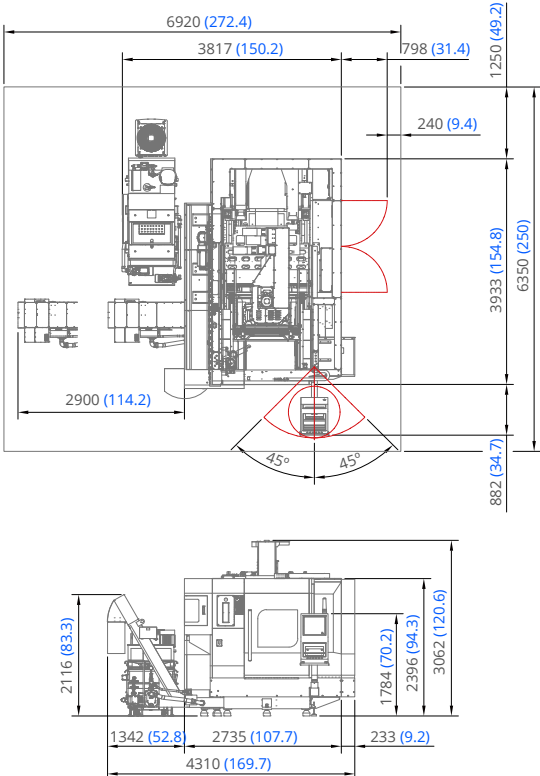

## G6 MPC2 (with 80 tools ATC and chain type chip conveyor)

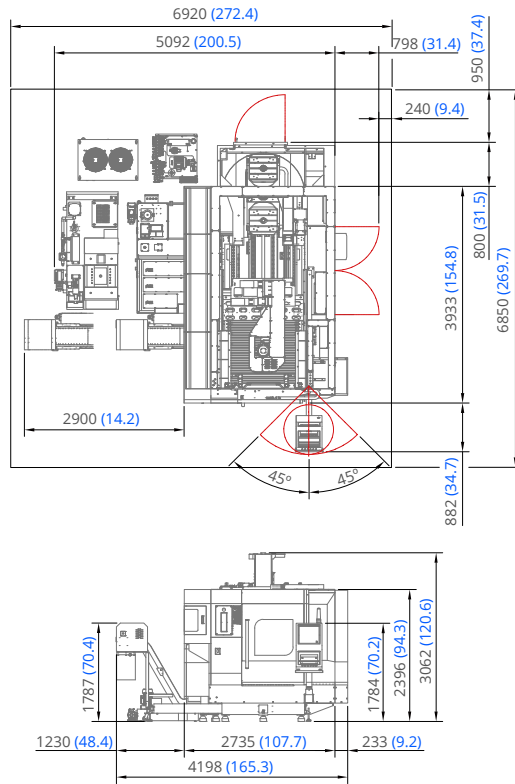

## G6 MPC6 (with 80 tools ATC and chain type chip conveyor)

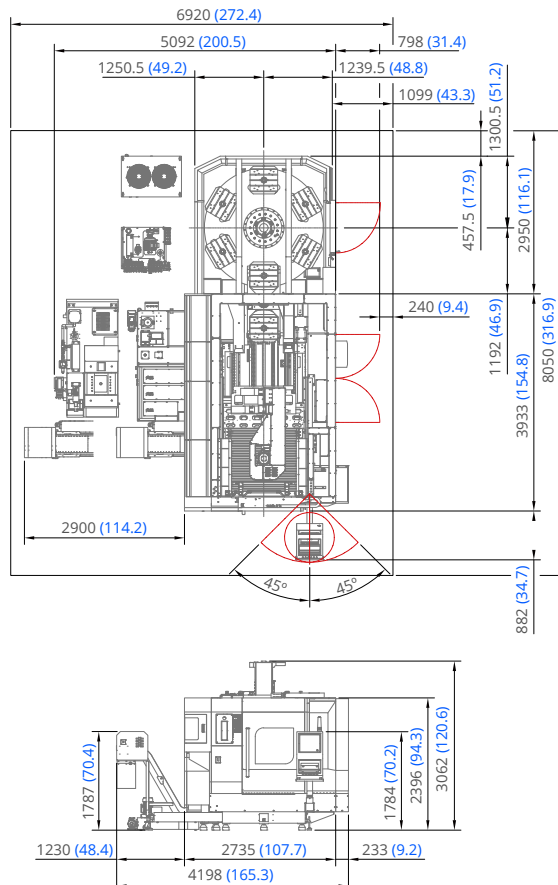

# G6 RPC (with 80 tools ATC and chain type chip conveyor)

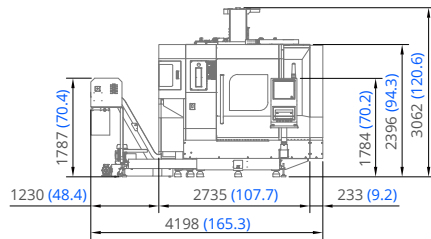
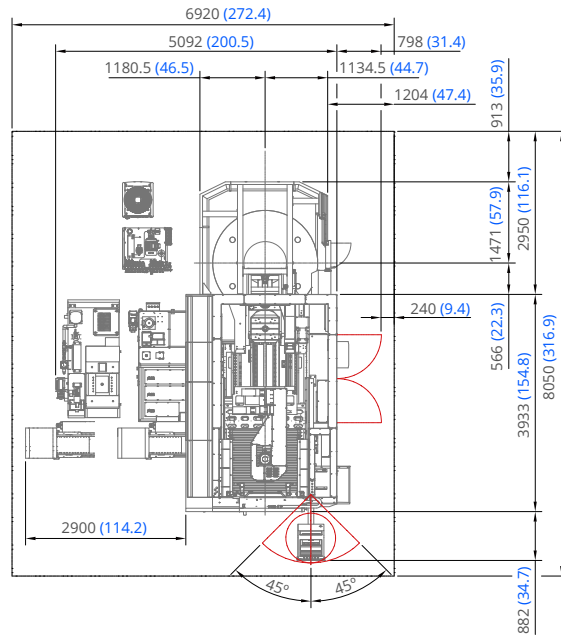

# INTERFERENCE

- Metric
- Inch

## G6

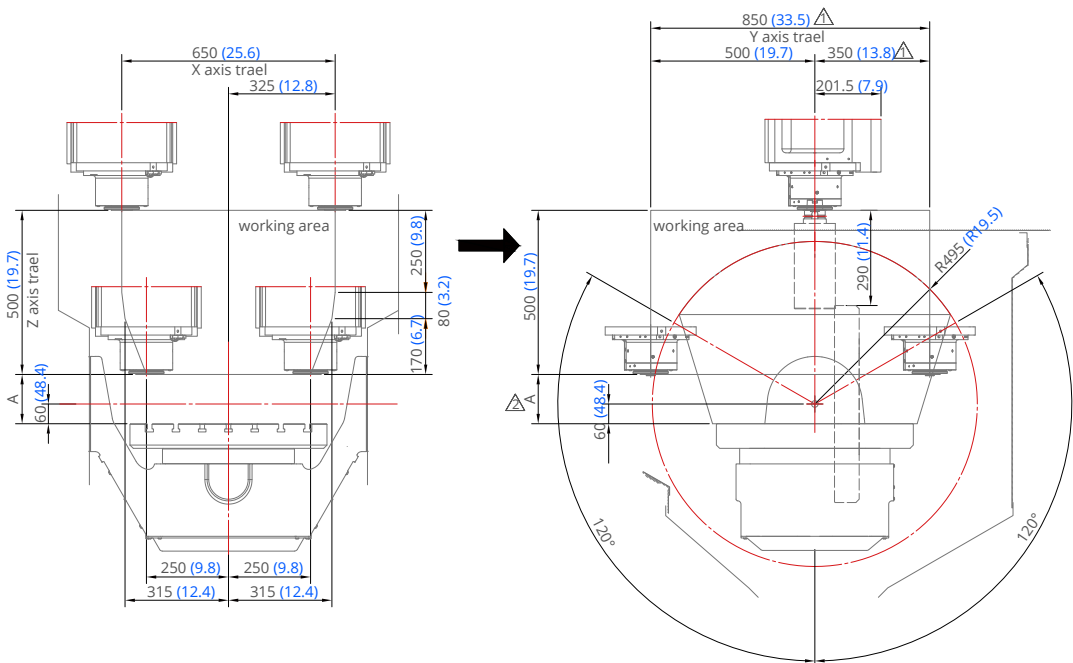



# G6 RPC

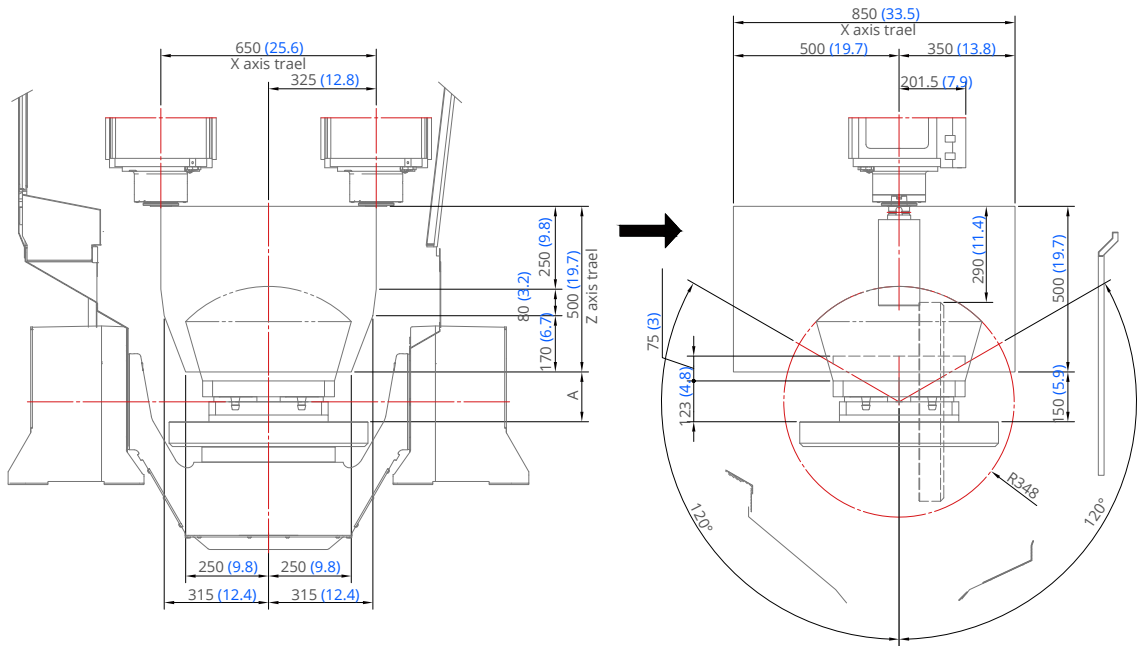

# TECHNICAL DATA

## COMMON DATA FOR G6

LINEAR AXES		
X travel (carriage left and right)	650 mm	25.6 in
Y travel (gantry back and forth)	850 mm	33.5 in
Z travel (headstock up and down)	500 mm	19.7 in
Max feedrate X/Y/Z	36 m/min	1417 in/min
Guideways type	Roller	
Guideways size X/Y/Z	45 mm	1.7 in
Distance between X/Y guides	500/1110 mm	19.7/43.7 in
Ballscrew diameter/pitch	40/12 mm	1.6/0.5 in
X axis motor power/torque	5/17.7 kW/Nm	6.7/13 hp/ Ft/lbs
Y axis motor power/torque (x2)	5.7/21.6 (x2) kW/Nm	7.6/15.9(x2) hp/ Ft/lbs
Z axis motor power/torque	6/26.1 kW/Nm	8/19.3 hp/ Ft/lbs
ROTARY AXES		
A range (swiveling)	±120 deg	
C (rotary)	360 deg	
SPINDLE		
Spindle speed	20000 rpm	
Spindle taper	HSK-A63	
Transmission	Built-in	
Motor type	Asynchronous	
Bearing typefront/rear	Angular ball	
Bearing cooling and lubrication	Oil-air	
Power S1/S6-40%	25/32 kW	33/53 hp
Torque S1/S6-40%	86/111 Nm	64.2/99.6 Ft/lbs
SPINDLE		
Spindle speed	15000 rpm	
Spindle taper	HSK-A63	
Transmission	Built-in	
Motor type	Asynchronous	
Bearing typefront/rear	Angular ball	
Bearing cooling and lubrication	Oil-air	
Power S1/S6-40%	30/38 kW	40/61 hp
Torque S1/S6-40%	127/166 Nm	95.9/147.5 Ft/lbs
ACCURACY (VDI/DGQ 3441)		
Positioning	0.005 mm	0.0002 in
Repeatability	±0.0025 mm	±0.0001 in
EXTERNAL COOLANT SUPPLY		
External nozzels coolant supply (number) pressure	(4x) 3 bar	(4x) 43.5 psi
External nozzels air supply (number) pressure	(2x) 6 bar	(2x) 87 psi
Tank capacity	1500 L	396.2 US gal
SPINDLE THROUGH COOLANT SUPPLY (STD)		
High pressure pump	40/70 bar	580.1/1015.2 psi
CONTROL UNIT		
Heidenhain	TNC 640/TNC 7	
Siemens	Sinumerik one	
Fanuc	31i-B5 Plus	

\* Specifications are subject to change without notice.

## COMMON DATA FOR G6 (CONT.)

TOOL CHANGER		
Change type	Chain type	
Carousel driving system	Servomotor	
Magazine positions	Chain type: 80(std), 120(opt)	
Tool shank type	HSK-A63	
Maximum tool length	300 mm	11.8 in
Max tool diameter (with adjacent pot empty)	Ø75/Ø125 mm	Ø3/Ø4.9 in
Maximum tool weight	8 kg	17.6 lbs
Max. loading weight	Chain type: 640/800 kg	Chain type: 1410/1763 lbs

## COMMON DATA FOR G6/G6 RPC(CONT.)

WORKPIECE AND TABLE		
Table size	Ø600 mm	Ø23.6 in
Maximum table load	600 kg	1323 lbs
T-slot ( w/pitch/no)	14x80x7 mm	0.5x3.1x0.3 in
Number and hydraulic ports	3	
Working pressure of hydraulic ports	80 bar	1160.3 psi
Number and pneumatic ports	1	
Working pressure of pneumatic ports	6 bar	87 psi
SPINDLE		
Spindle taper	HSK-A63	
Spindle nose to rotary table clamping surface	150~650	
ROTARY AXES		
Maximum swiveling (A) speed	100 rpm	
Maximum rotary (C) speed	200 rpm	
Driving system in swiveling (A) axis	Dual Torque Motor	
Driving system in rotary (C) axis	Torque motor	
Brake type of swivelling (A) axis	Hydraulic clamping	
Brake type of rotary (C) axis	Hydraulic clamping	
MEASURING FEEDBACK		
Linear axes type	Linear scale	
Linear axes resolution	0.1 µm	
Rotary axes type	Rotary scale	
Rotary axes accuracy	±5"	
SUPPLES		
Installed power	60 kVA	
DIMENSION		
Length (w conveyor)	STD: 4250 mm	STD: 13.9 Ft
	RPC: 4280 mm	RPC: 13.7 Ft
Width	STD: 4000 mm	STD: 13.1 Ft
	RPC: 6040 mm	RPC: 19.8 Ft
Height	3035 mm	10 Ft
Weight	STD: 12000 kg	STD: 26455 lbs
	RPC: 20000 kg	RPC: 44092 lbs
Floor Space	STD: 2970x4000 mm	STD: 9.7x13.1 Ft
	RPC: 3380x6040 mm	RPC: 11x19.8 Ft

\* Specifications are subject to change without notice.

## SPECIFIC DATA FOR G6 MPC

WORKPIECE AND TABLE		
Table size	Ø500x500 mm	Ø19.7x19.7 in
Maxium table load	400 kg	882 lbs
T-slot ( w/pitch/no)	14x100x5 mm	0.5x3.9x0.2 in
Threaded hole	M12x100 mm	M0.4x3.9 in
Number and hydraulic ports		3
Working pressure of hydraulic ports	80 bar	1160.3 psi
Number and pneumatic ports		1
Working pressure of pneumatic ports	6 bar	87 psi
SPINDLE		
Spindle taper		HSK-A63
Spindle nose to rotary table clamping surface		130~630
ROTARY AXES		
Maximum Swiveling (A) speed		100 rpm
Maximum rotary (C) speed		200 rpm
Driving system in swiveling (A) axis		Dual torque motor
Driving system in rotary (C) axis		Torque motor
Brake type of swiveling (A) axis		Hydraulic clamping
Brake type of rotary (C) axis		Hydraulic clamping
MEASURING FEEDBACK		
Linear axes type		Linear scale
Linear axes resolution		0.1 µm
Rotary axes type		Rotary scale
Rotary axes accuracy		±5"
APC SYSTEM		
Exchange time		60 sec
SUPPLIES		
Installed power		60 kVA
DIMEMSION		
Length (w conveyor)	3990 mm	13 Ft
Width	4750 mm	15.6 Ft
Height	2970 mm	9.7 Ft
Weight	16000 kg	35275 lbs
Floor Space	3150x4750 mm	10.3x15.6 Ft

\* Specifications are subject to change without notice.

## SPECIFIC DATA FOR G6 MT

WORKPIECE AND TABLE		
Table size	Ø500 mm	Ø19.7 in
Maxium table load	350 kg(Turning)/500 kg(Milling)	771 lbs(Turning)/1102 lbs(Milling)
T-slot ( w/pitch/no)	14x30x12 mm	0.5x1.2x0.5 in
SPINDLE		
Spindle taper	HSK-T63	
Spindle nose to rotary table clamping surface	150~650	
ROTARY AXES		
Maximum Swiveling (A) speed	15 rpm(Turning) 100 rpm(Milling)	
Maximum rotary (C) speed	1500 rpm(Turning) 100 rpm(Milling)	
Driving system in swiveling (A) axis	Dual Torque Motor	
Driving system in rotary (C) axis	Torque motor	
Brake type of swiveling (A) axis	Hydraulic clamping	
Brake type of rotary (C) axis	Hydraulic clamping	
MEASURING FEEDBACK		
Linear axes type	Linear scale	
Linear axes resolution	0.1 µm	
Rotary axes type	Rotary scale	
Rotary axes accuracy	±5"	
SUPPLIES		
Installed power	60 kVA	
DIMENSION		
Length (w conveyor)	3560 mm	11.7 Ft
Width	4900 mm	16 Ft
Height	2970 mm	9.7 Ft
Weight	12000 kg	26456 lbs
Floor Space	3560x4900 mm	11.7x16 Ft

\* Specifications are subject to change without notice.



**AXILE MACHINE**

E [info@axilemachine.com](mailto:info@axilemachine.com)

W [www.axilemachine.com](http://www.axilemachine.com)

©2023 AXILE. All rights reserved.